



[www.clarinitalia.com](http://www.clarinitalia.com)

# TRANSENNE

**CLARIN ITALIA Srl**

P. I. 00862491206 – c. s. € 20.000,00 i.v.

Sede Legale Vicolo S. Damiano,3 – 40124 Bologna

**Direzione Commerciale e Tecnica**

**Sede Amministrativa**

Via A. Gramsci 16/L - 00065 Fiano Romano (Roma)

Tel 0765 - 480012 - Fax 0765 - 388002

e-mail: [info@clarinitalia.com](mailto:info@clarinitalia.com)



**NELLO SPORT E NELLO SPETTACOLO** DA SEMPRE

**CLARIN**

ITALIA

TRIBUNE

[www.clarinitalia.com](http://www.clarinitalia.com)



## IL PRODOTTO

SEDE LEGALE  
Vicolo S. Damiano, 3 - 40124 Bologna P.IVA: 00862491206

DIREZIONE COMMERCIALE E TECNICA - SEDE AMMINISTRATIVA  
Via A. Gramsci, 16/L - 00065 Fiano Romano (RM)  
Tel: 0765/480012 - 489182 Fax: 0765/388002  
e-mail: [info@clarinitalia.com](mailto:info@clarinitalia.com) [www.clarinitalia.com](http://www.clarinitalia.com)



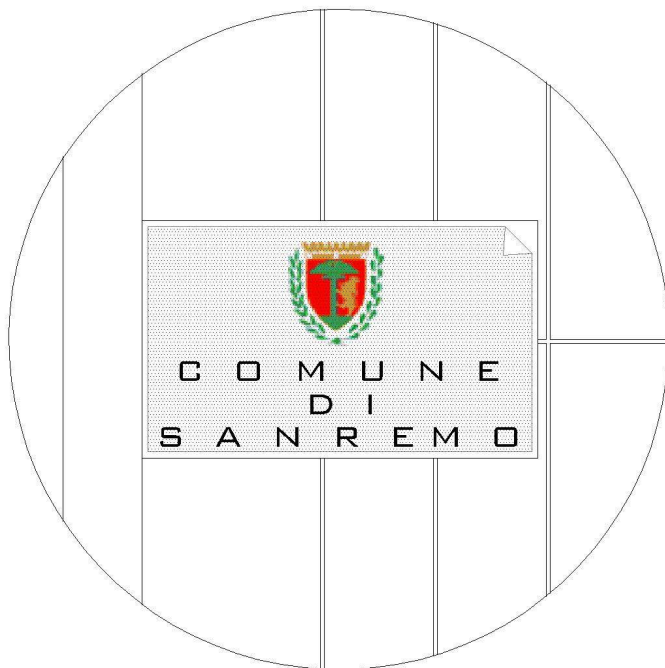
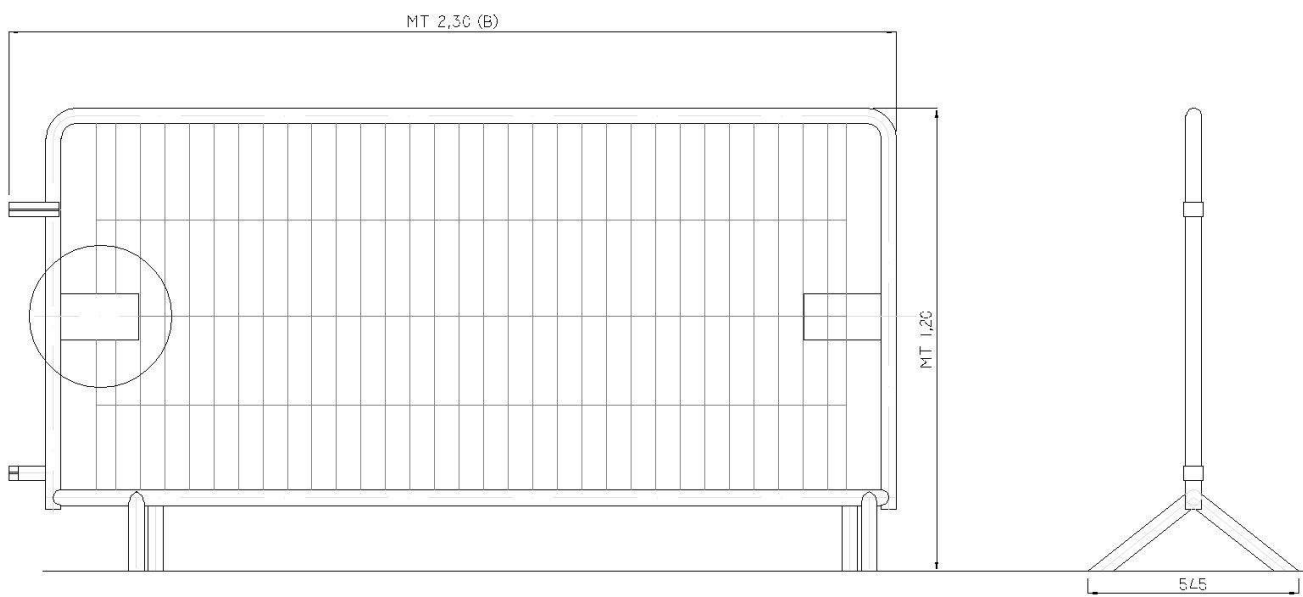

Possibilità di rapida personalizzazione con adesivi o vernici

## LA TRANSENNA CL1

SEDE LEGALE  
Vicolo S. Damiano, 3 - 40124 Bologna P.IVA: 00862491206

DIREZIONE COMMERCIALE E TECNICA - SEDE AMMINISTRATIVA  
Via A. Gramsci, 16/L - 00065 Fiano Romano (RM)  
Tel: 0765/480012 - 489182 Fax: 0765/388002  
e-mail: info@clarinitalia.com www.clarinitalia.com



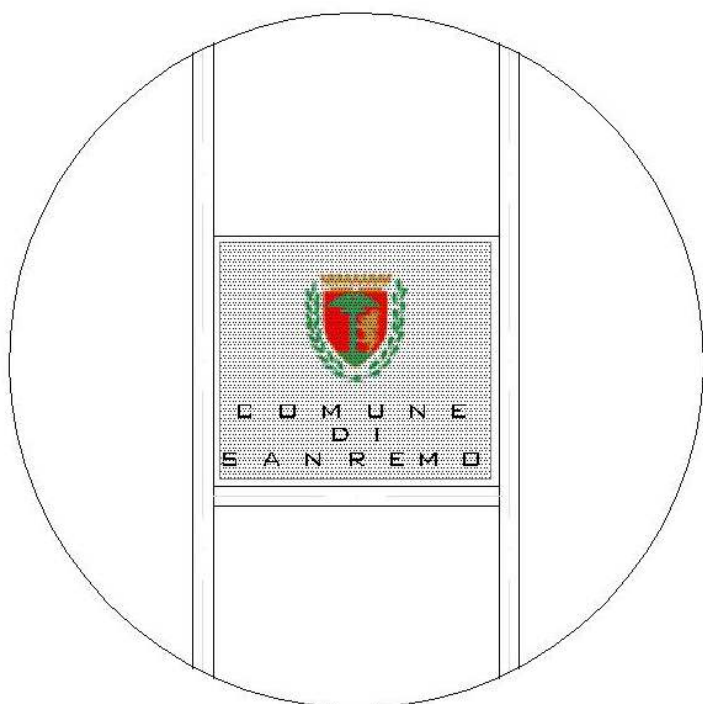
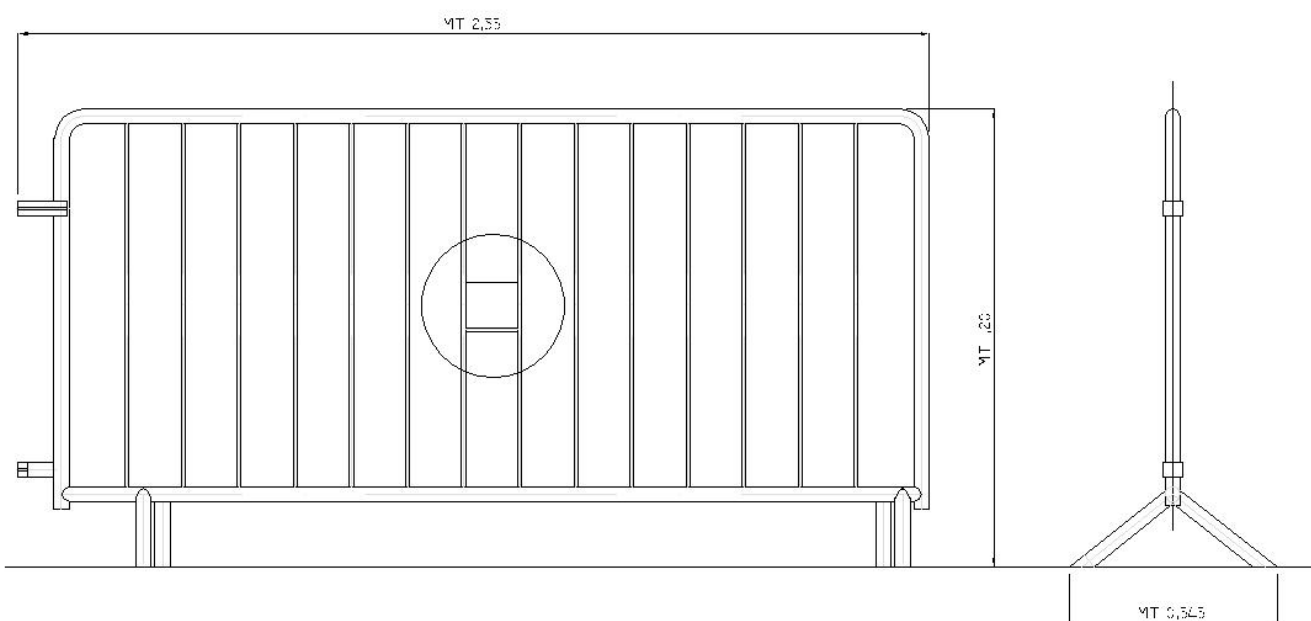

Possibilità di rapida  
personalizzazione con  
adesivi o vernici

## LA TRANSENNA CL2

SEDE LEGALE  
Vicolo S. Damiano, 3 - 40124 Bologna P.IVA: 00862491206

DIREZIONE COMMERCIALE E TECNICA - SEDE AMMINISTRATIVA  
Via A. Gramsci, 16/L - 00065 Fiano Romano (RM)  
Tel: 0765/480012 - 489182 Fax: 0765/388002  
e-mail: info@clarinitalia.com www.clarinitalia.com



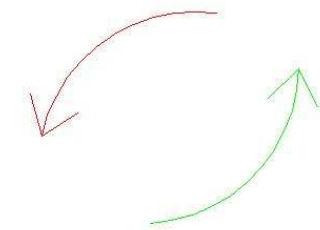
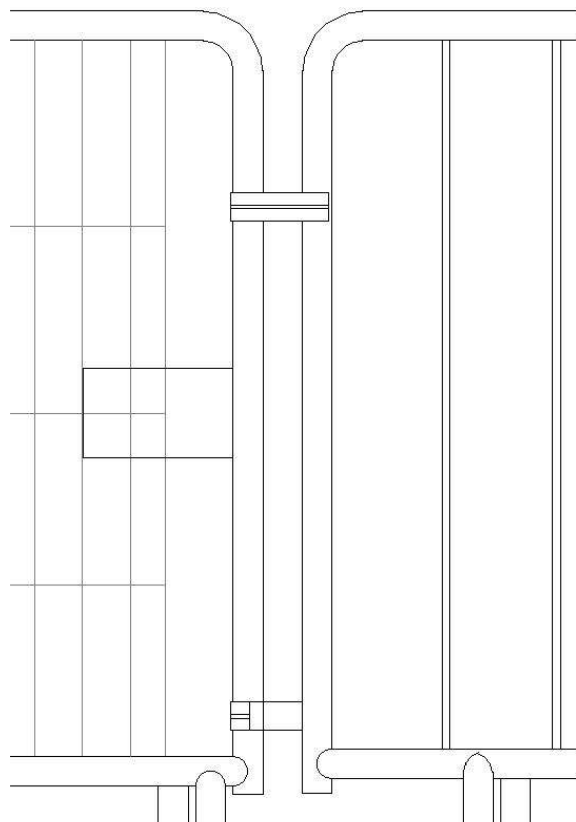
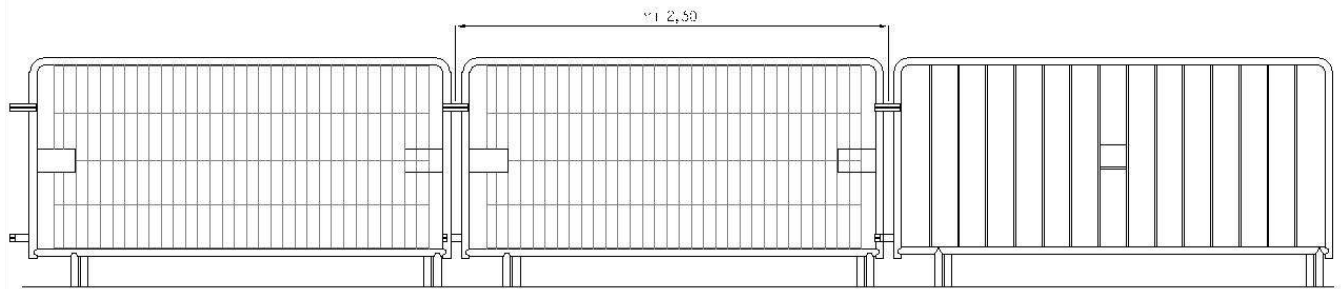

Aggancio con una  
semplice rotazione

intercambiabilità  
tra i modelli

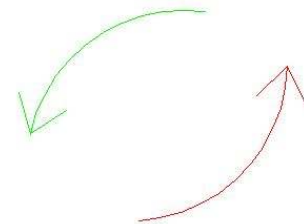

## IL MONTAGGIO

SEDE LEGALE  
Vicolo S. Damiano, 3 - 40124 Bologna P.IVA: 00862491206

DIREZIONE COMMERCIALE E TECNICA - SEDE AMMINISTRATIVA  
Via A. Gramsci, 1 G/L - 00065 Fiano Romano (RM)  
Tel: 0765/480012 - 489182 Fax: 0765/388002  
e-mail: info@clarinitalia.com www.clarinitalia.com



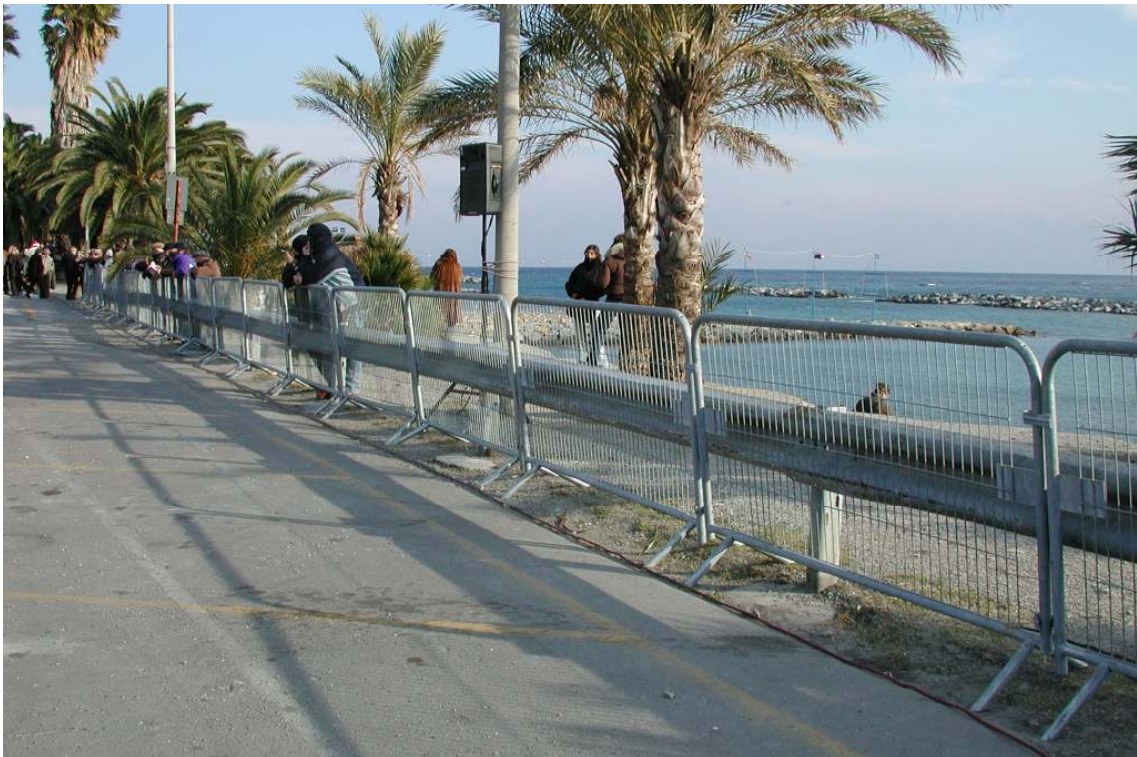
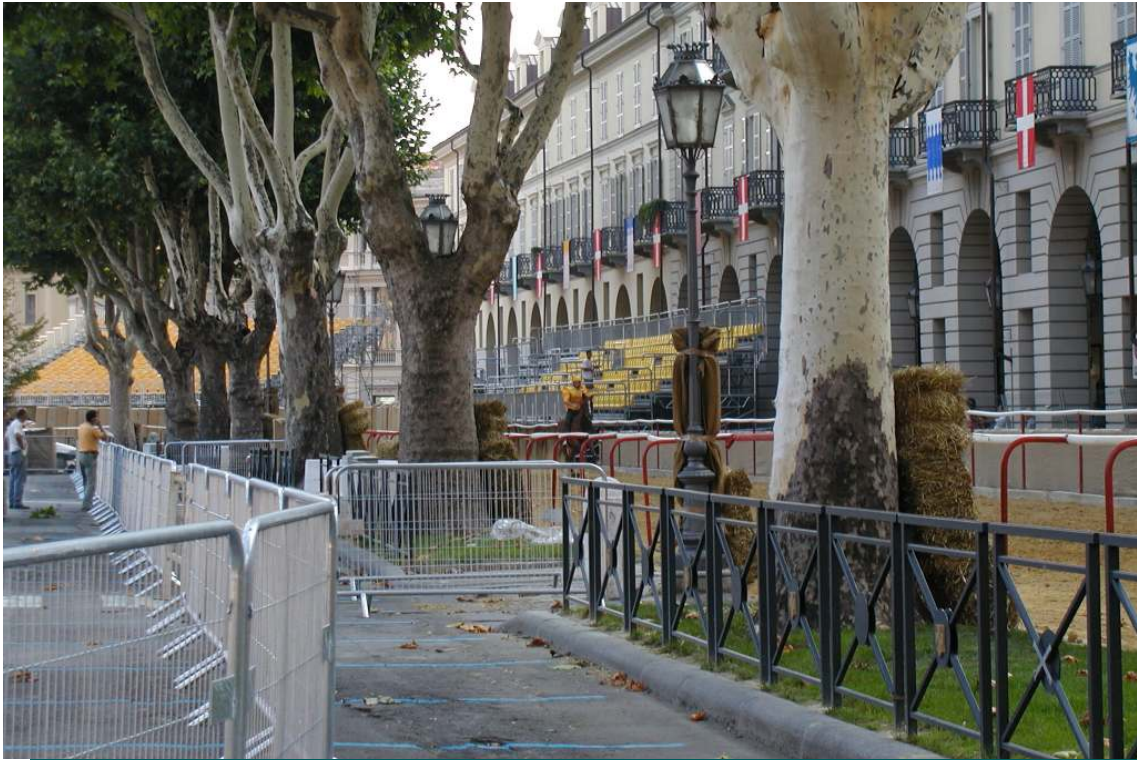

## IL PRODOTTO

SEDE LEGALE  
Vicolo S. Damiano, 3 - 40124 Bologna P.IVA: 00862491206

DIREZIONE COMMERCIALE E TECNICA - SEDE AMMINISTRATIVA  
Via A. Gramsci, 1 G/L - 00065 Fiano Romano (RM)  
Tel: 0765/480012 - 489182 Fax: 0765/388002  
e-mail: [info@clarinitalia.com](mailto:info@clarinitalia.com) [www.clarinitalia.com](http://www.clarinitalia.com)



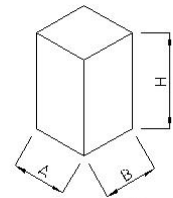
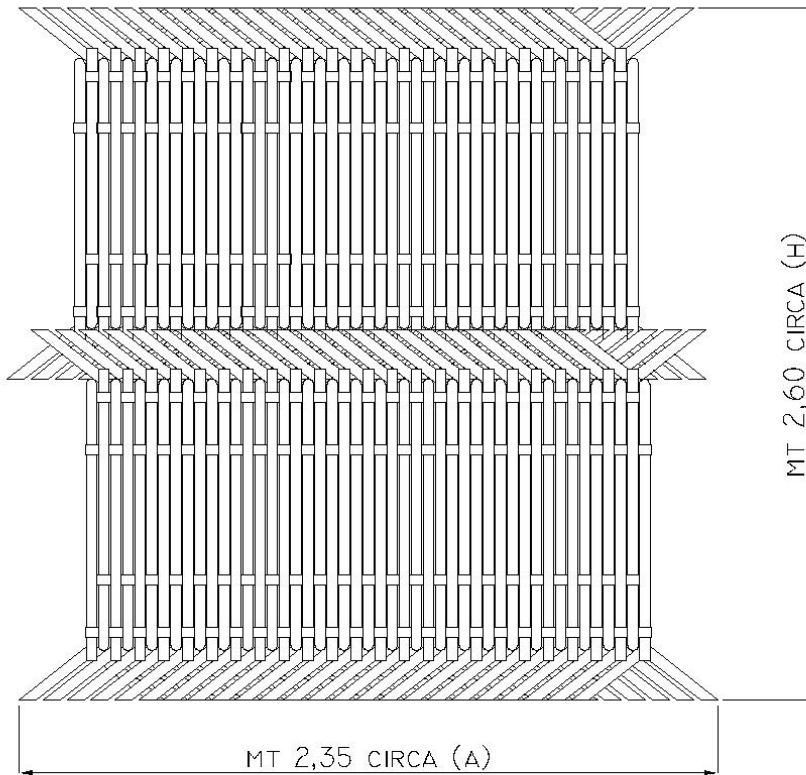

A= MT 2,35 CIRCA  
 B= MT 2,30 CIRCA  
 H= MT 2,60 CIRCA

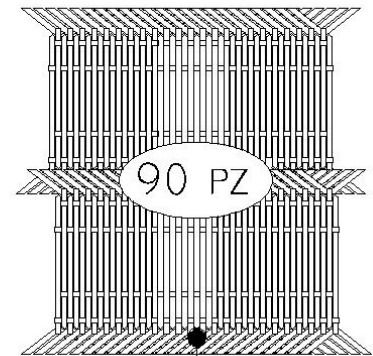

1750 KG



1940 KG

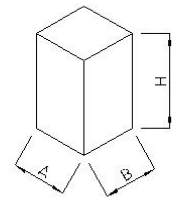
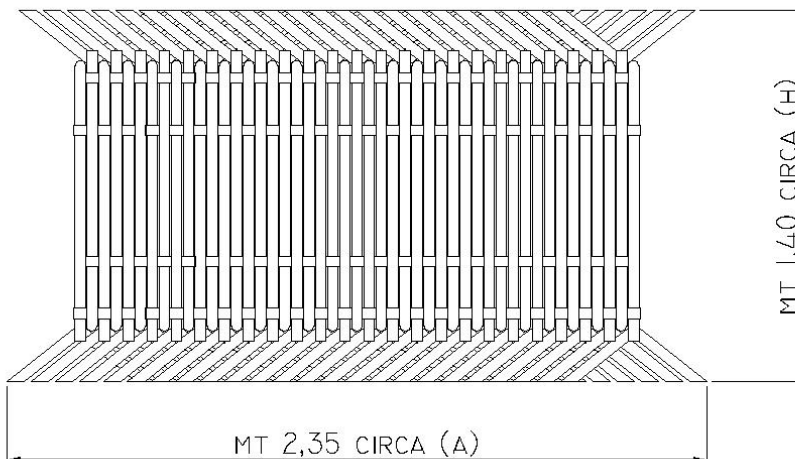

A= MT 2,35 CIRCA  
 B= MT 2,30 CIRCA  
 H= MT 1,40 CIRCA

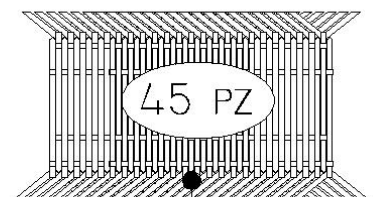

855 KG



870 KG

## I PACCHI

SEDE LEGALE  
 Vicolo S. Damiano, 3 - 40124 Bologna P.IVA: 00862491206

DIREZIONE COMMERCIALE E TECNICA - SEDE AMMINISTRATIVA  
 Via A. Gramsci, 1 G/L - 00065 Fiano Romano (RM)  
 Tel: 0765/480012 - 489182 Fax: 0765/388002  
 e-mail: info@clarinitalia.com www.clarinitalia.com





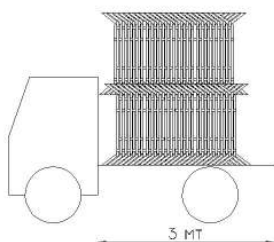

SU UN FURGONE (TIPO DAILY) CON CASSONE LUNGO MT 3,00 E LARGO MT 2,35 POSSONO ESSERE CARICATE **FINO A 120 TRANSENNE**, PARI A **MT 276**

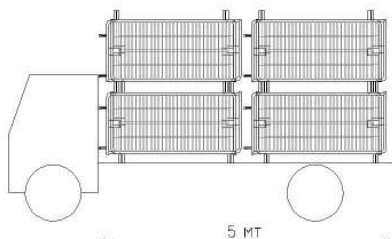

SU UN AUTOCARRO CON CASSONE LUNGO MT 5,00 E LARGO MT 2,40 POSSONO ESSERE CARICATE **FINO A 180 TRANSENNE**, PARI A **MT 414**

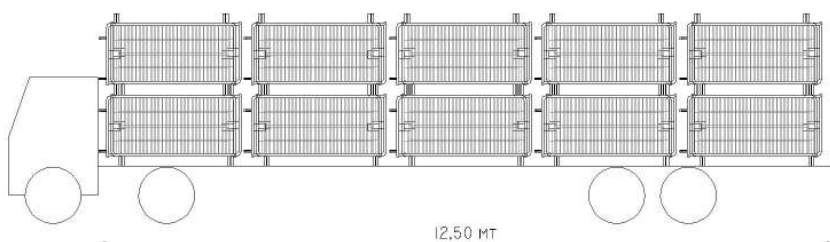

SU UN AUTOARTICOLATO CON CASSONE LUNGO MT 12,50 E LARGO MT 2,45 POSSONO ESSERE CARICATE **FINO A 450 TRANSENNE**, PARI A **MT 1035**

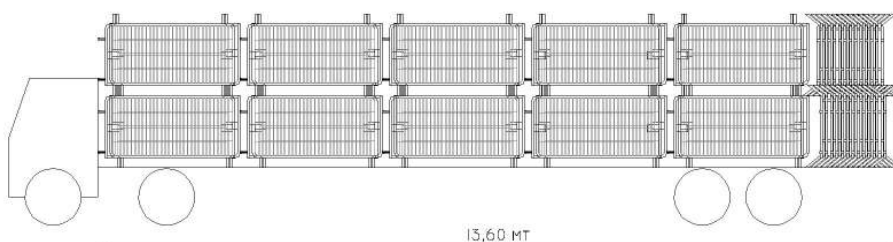

SU UN AUTOARTICOLATO CON CASSONE LUNGO MT 13,60 E LARGO MT 2,45 POSSONO ESSERE CARICATE **FINO A 525 TRANSENNE**, PARI A **MT 1208**

## I CARICHI

SEDE LEGALE  
Vicolo S. Damiano, 3 - 40124 Bologna P.IVA: 00862491206

DIREZIONE COMMERCIALE E TECNICA - SEDE AMMINISTRATIVA  
Via A. Gramsci, 1 G/L - 00065 Fiano Romano (RM)  
Tel: 0765/480012 - 489182 Fax: 0765/388002  
e-mail: info@clarinitalia.com www.clarinitalia.com



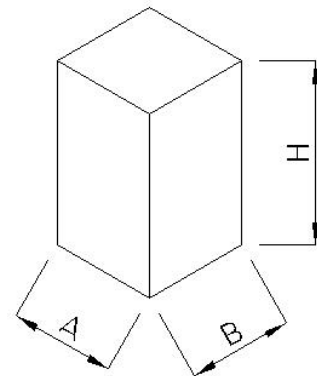
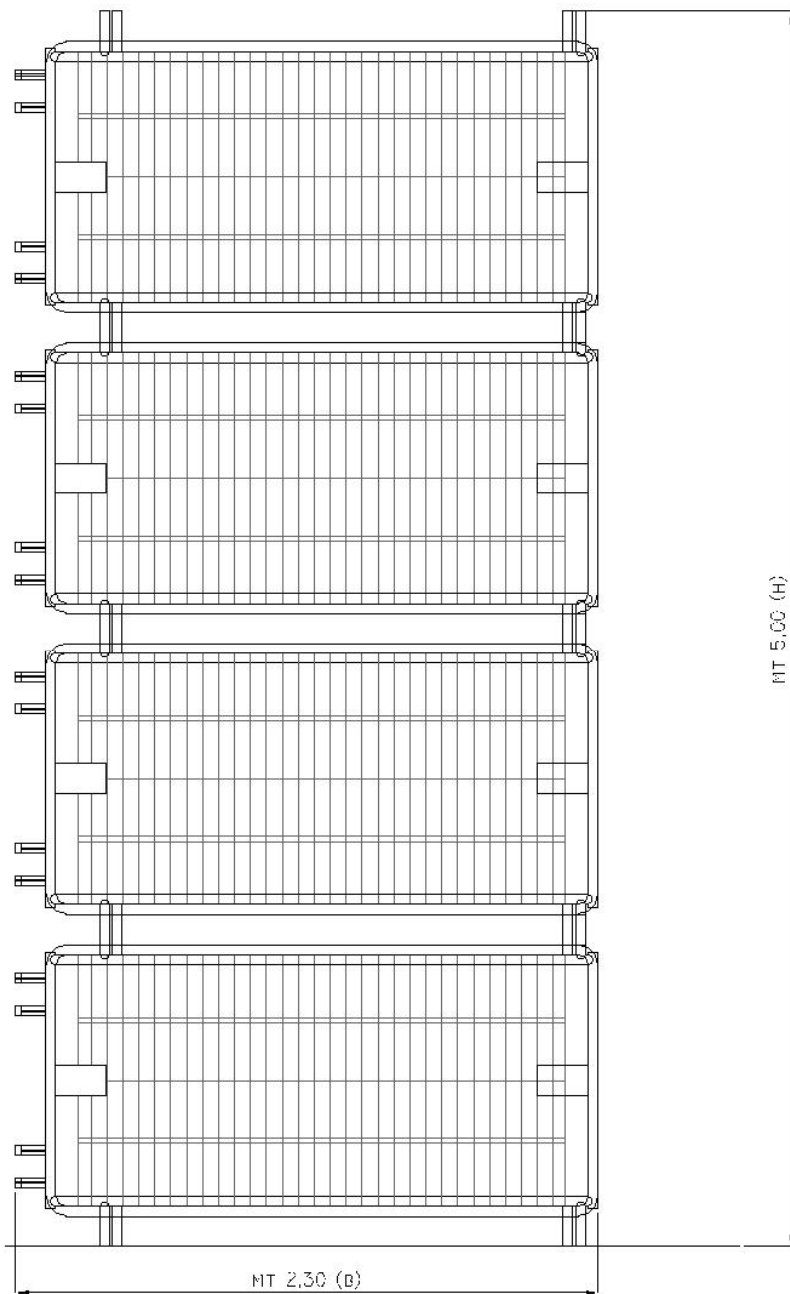

A = MT 2,35 CIRCA  
 B = MT 2,30 CIRCA  
 H = MT 5,00 CIRCA

## IL MAGAZZINO

SEDE LEGALE  
 Vicolo S. Damiano, 3 - 40124 Bologna P.IVA: 00862491206

DIREZIONE COMMERCIALE E TECNICA - SEDE AMMINISTRATIVA  
 Via A. Gramsci, 1 G/L - 00065 Fiano Romano (RM)  
 Tel: 0765/480012 - 489182 Fax: 0765/388002  
 e-mail: info@clarinitalia.com www.clarinitalia.com



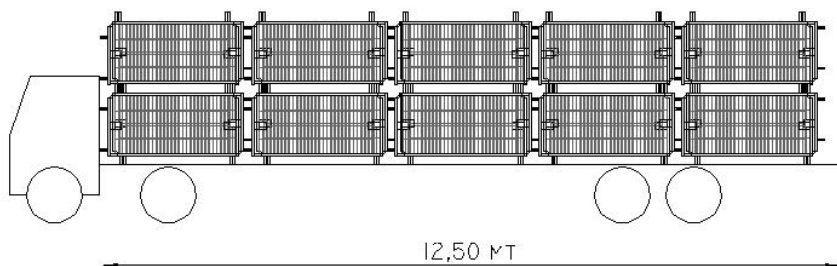

Un autoarticolato con cassone lungo mt 12,50 **carica 300 transenne tradizionali** da mt 2,50, pari a mt 750.  
Lo stesso mezzo **carica le nostre transenne per mt 1035.**

**MAGGIORE  
CAPACITA' DI  
CARICO +27,50%**

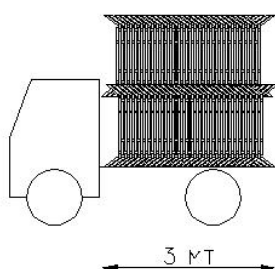

Un furgone (tipo Daily) con cassone lungo mt 3,00 **carica 50 transenne tradizionali** da mt 2,50, pari a mt 125.  
Lo stesso mezzo **carica le nostre transenne per mt 276.**

**MAGGIORE CAPACITA' DI  
CARICO +120%**

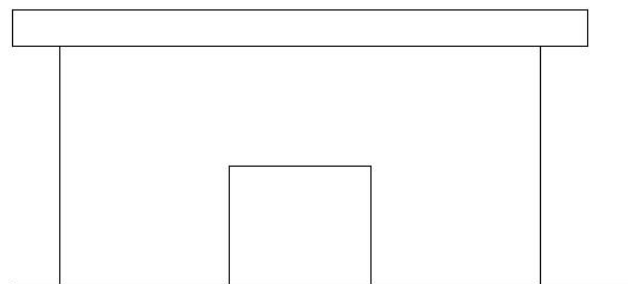

Un capannone di 500 mq **immagazzina n° 5.400 transenne tradizionali**, pari a mt 13.500.

Lo stesso capannone **immagazzina n° 16.200 nostre transenne**, pari a mt 37.260.

**MAGGIORE CAPACITA' DI  
IMMAGAZZINAMENTO +276%**

## IL CONFRONTO

SEDE LEGALE  
Vicolo S. Damiano, 3 - 40124 Bologna P.IVA: 00862491206

DIREZIONE COMMERCIALE E TECNICA - SEDE AMMINISTRATIVA  
Via A. Gramsci, 1 G/L - 00065 Fiano Romano (RM)  
Tel: 0765/480012 - 489182 Fax: 0765/388002  
e-mail: info@clarinitalia.com www.clarinitalia.com



**NELLO SPORT E NELLO SPETTACOLO** DA SEMPRE

**CLARIN**

ITALIA

TRIBUNE

[www.clarinitalia.com](http://www.clarinitalia.com)

**CLARIN ITALIA Srl**

P. I. 00862491206 – c. s. € 20.000,00 i.v.

Sede Legale Vicolo S. Damiano,3 – 40124 Bologna

**Direzione Commerciale e Tecnica**

**Sede Amministrativa**

Via A. Gramsci 16/L - 00065 Fiano Romano (Roma)

Tel 0765 - 480012 - Fax 0765 - 388002

e-mail: [info@clarinitalia.com](mailto:info@clarinitalia.com)